

THE *Right* PRODUCTS
PEOPLE
CHOICE

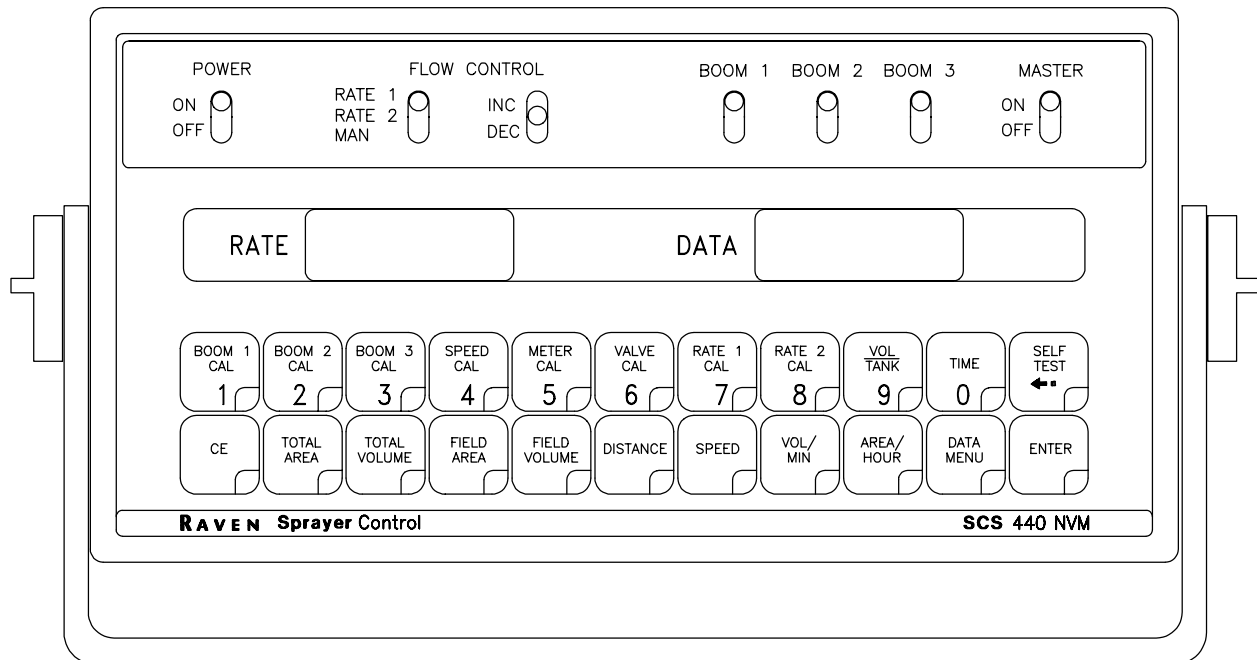

FLOW CONTROL DIVISION

SCS 440



INSTALLATION AND SERVICE MANUAL

N O T I C E

The use of the suspension type fertilizers and lime slurries will significantly reduce the life of the plastic parts in the Flow Meter and motorized Control Valve. Check the rotor and inlet hub assembly in the Flow Meter frequently for worn parts. Excessive wear can affect accuracy.

Do not attempt to modify or lengthen any of the three-wire Speed Sensor or Flow Meter cables. Extension cables are available from your Dealer.

W A R N I N G

Disconnect console before jump starting, charging battery, or welding on equipment.

THIS CARD IS PROVIDED FOR YOUR CONVENIENCE. PENCIL IN YOUR CALIBRATION NUMBERS FOR FUTURE REFERENCE.
 CUT ON DOTTED LINE, FOLD, AND INSERT INTO PLASTIC ENVELOPE.

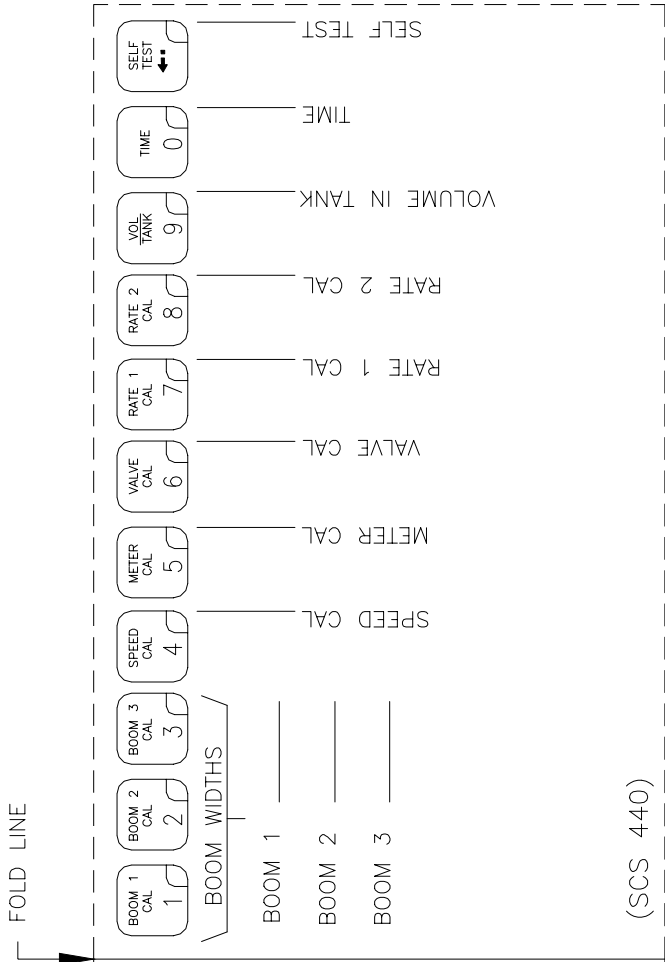
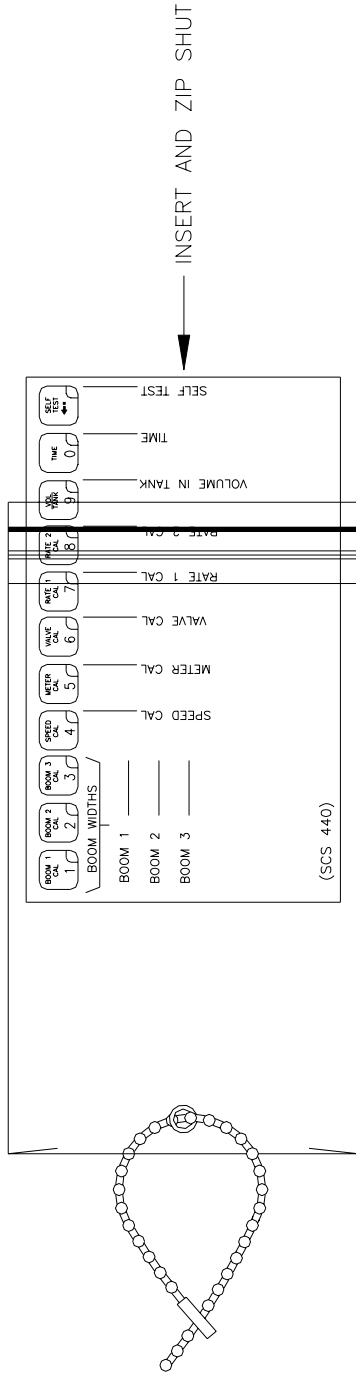



CUT ON DOTTED LINE

WARNING: DISCONNECT CONSOLE BEFORE JUMP STARTING,
 CHARGING BATTERY, OR WELDING ON EQUIPMENT.

DATA ENTRY EXAMPLE: TO ENTER VALVE CAL.

1. PRESS VALVE CAL KEY.
2. PRESS ENTER KEY.
3. PRESS KEYS REQUIRED, TO ENTER PROPER NUMBER.

(EXAMPLE: KEYS    FOR 2123)

4. PRESS ENTER KEY AGAIN.

(SCS 440)



RAVEN INDUSTRIES

LIMITED WARRANTY

WHAT IS COVERED?

This warranty covers all defects in workmanship or materials in your Raven Flow Control Product under normal use, maintenance, and service.

HOW LONG IS THE COVERAGE PERIOD?

This warranty coverage runs for 12 months from the purchase date of your Raven Flow Control Product. This warranty coverage applies only to the original owner and is not transferrable.

HOW CAN YOU GET SERVICE?

Bring the defective part, and proof of date of purchase, to your local dealer. If your dealer agrees with the warranty claim, he will send the part, and proof of purchase to his distributor or to Raven for final approval.

WHAT WILL RAVEN INDUSTRIES DO?

When our inspection proves the warranty claim, we will, at our option, repair or replace the defective part and pay for return freight.

WHAT DOES THIS WARRANTY NOT COVER?

Raven Industries will not assume any expense or liability for repairs made outside our plant without written consent. We are not responsible for damage to any associated equipment or product and will not be liable for loss of profit or other special damages. The obligation of this warranty is in lieu of all other warranties, expressed or implied, and no person is authorized to assume for us any liability. Damages caused by normal wear and tear, mis-use, abuse, neglect, accident, or improper installation and maintenance are not covered by this warranty.

TABLE OF CONTENTS

SYMBOL DEFINITION	2
INTRODUCTION	3
INSTALLATION.....	4
1. MOUNTING THE RAVEN RADAR SPEED SENSOR	4
2. MOUNTING THE FLOW METER	5
3. MOUNTING THE CONTROL VALVE	5
4. MOUNTING THE CONSOLE AND CABLING	6
BATTERY CONNECTIONS	7
CONSOLE FEATURES.....	8
CONSOLE CALIBRATION.....	9
1. CALCULATING "BOOM CAL"	9
2. CALCULATING "SPEED CAL"	10
3. CALCULATING "METER CAL"	10
4. CALCULATING "VALVE CAL"	11
5. CALCULATING "RATE 1 AND RATE 2 CAL"	12
CONSOLE PROGRAMMING.....	13
1. INITIAL CONSOLE PROGRAMMING	14
2. OTHER DISPLAY FEATURES	17
3. SELF TEST FEATURE	17
4. VOLUME/MINUTE RATE FAULT	18
5. VOLUME/AREA RATE ALARM	18
6. LOW TANK FAULT	18
7. AUTOMATIC RATE +/-	18
8. CONTROL VALVE DELAY	19
9. SEQUENCE TO ACTIVATE DATA-LOCK	19
10. SEQUENCE TO CHANGE DATA-LOCK	19
11. ENTER MODE SEQUENCE WITH ACTIVATED DATA-LOCK	19
12. DATA MENU	20
13. DECIMAL SHIFT	25
INITIAL SYSTEM SET-UP.....	26
INITIAL SYSTEM FIELD TEST	27
PREVENTIVE MAINTENANCE	27
TROUBLESHOOTING GUIDE.....	28

APPENDIXES

1. WHEEL DRIVE SPEED SENSOR INSTALLATION AND CALIBRATION	31
2. SPEEDOMETER DRIVE SPEED SENSOR INSTALLATION AND CALIBRATION.....	34
3. ALTERNATE BY-PASS LINE PLUMBING SYSTEM.....	36
4. PROCEDURE TO TEST SPEED SENSOR EXTENSION CABLES	38
5. PROCEDURE TO TEST FLOW METER CABLES	39
6. FLOW METER MAINTENANCE AND ADJUSTMENT PROCEDURE	40
7. PROCEDURE TO RE-CALIBRATE FLOW METER	41
8. REMOTE SWITCH OPTION	42
9. SERIAL INTERFACE.....	43
10. SCS 440 COMMUNICATION STRINGS.....	44

REPLACEMENT PARTS SHEETS

SYMBOL DEFINITION

GPM	- Gallons per minute	cm	- Centimeters
lit/min	- Liters per minute	dm	- Decimeters
dl/min	- Deciliter per minute	m	- Meter
PSI	- Pounds per square inch	MPH	- Miles per hour
kPa	- Kilopascal	km	- Kilometers
GPA	- Gallon per acre	km/h	- Kilometers per hour
lit/ha	- Liter per hectare	US	- Volume per acre
ml/ha	- Milliliter per hectare	SI	- Volume per hectare
GPK	- Gallons per 1,000 sq. ft.	TU	- Volume per 1,000 sq. ft.
mm	- Millimeters	[]	- Metric numbers
		{}	- 1,000 sq. ft. numbers

METER CAL CONVERSIONS

To convert the METER CAL number simply divide the original number (number printed on Flow Meter label) by the desired conversion factor.

FOR EXAMPLE:

$$\frac{\text{Original METER CAL No.}}{128} = \text{METER CAL No. for displays in Fluid Ounces}$$

$$\frac{\text{Original METER CAL No.}}{3.785} = \text{METER CAL No. for displays in Liters}$$

$$\frac{\text{Original METER CAL No.}}{\text{Weight of one gallon}} = \text{METER CAL No. for displays in Pounds}$$

LIQUID CONVERSIONS

U.S. Gallons x 128 = Fluid Ounces
U.S. Gallons x 3.785 = Liters
U.S. Gallons x 0.83267 = Imperial Gallons
U.S. Gallons x 8.34 = Pounds (Water)

LENGTH

1 millimeter (mm) = 0.039 inch
1 centimeter (cm) = 0.393 inch
1 meter (m) = 3.281 feet
1 kilometer (km) = 0.621 mile
1 inch = 25.4 millimeters; 2.54 centimeters
1 mile = 1.609 kilometers

PRESSURE

1 psi = 6.89 kPa
1 kPa = 0.145 psi

AREA

1 square meter = 10.764 square feet
1 hectare (ha) = 2.471 acres; 10,000 square meters
1 acre = 0.405 hectare; 43,560 square feet
1 square mile = 640 acres; 258.9 hectares

INTRODUCTION

The Raven SCS 440 (SPRAYER CONTROL SYSTEM) is designed to improve the uniformity of spray applications. Its performance relies on the installation and preventive maintenance of the complete sprayer. It is important that this Installation and Service Manual be reviewed thoroughly before operating the system. This manual provides a simple step-by-step procedure for installing and operating.

The SCS 440 system consists of a computer-based control Console, a Speed Sensor, a turbine type Flow Meter and a motorized Control Valve. The Console mounts directly in the cab of the vehicle for easy operator use. The Radar Speed Sensor is mounted to the frame of the vehicle or implement (Wheel Drive and Speedometer Drive Speed Sensors are also available). The motorized Control Valve and Flow Meter mount to the framework supporting the boom. Appropriate cabling is furnished for field installation.

The operator sets the target volume per area to be sprayed and the SCS 440 automatically maintains the flow regardless of vehicle speed or gear selection. A manual override switch allows the operator to manually control flow for system check-out and spot spraying. Actual volume per area being applied is displayed at all times. The SCS 440 additionally functions as an area monitor, speed monitor, and volume totalizer.

INSTALLATION

1. MOUNTING THE RAVEN RADAR SPEED SENSOR

See Appendix 1 for Wheel Drive Speed Sensor installation instructions.

See Appendix 2 for Speedometer Drive Speed Sensor installation instructions.

For mounting the radar, the following guidelines will assure proper installation: It is suggested that a large heavy mounting bracket, (P/N 107-0159-693) be attached to the vehicle frame for mounting the radar.

- 1) Park vehicle on level surface.
- 2) Select mounting site by considering the following:
 - a) The line of sight from the lens to the ground must not be obstructed by structures or tires. Obstructions must not come closer than 20 inches to the bottom of the radar. See **Figures 1 and 2**.
 - b) The radar lens must be parallel to the ground from front to back. Radar can be tilted out 0-15 degrees to provide more clearance and miss obstructions. See **Figure 2**.
 - c) The radar should be mounted so that the **length** of the radar is **parallel** with direction of vehicle travel.
- 3) Use carpenters level to verify that mounting bracket is parallel to the ground.
- 4) Bolt mounting bracket to implement.
- 5) Bolt radar to mounting bracket using mounting hardware. See **Figure 3**.
- 6) Connect radar with Radar Interface Cable (P/N 115-0159-539), to the Console. The Red wire should be connected to the Orange cable wire. The White wire should be connected to the White cable wire (See "**BATTERY CONNECTIONS**").

CAUTION: The connection of the radar power in reverse polarity could result in damage to the radar.

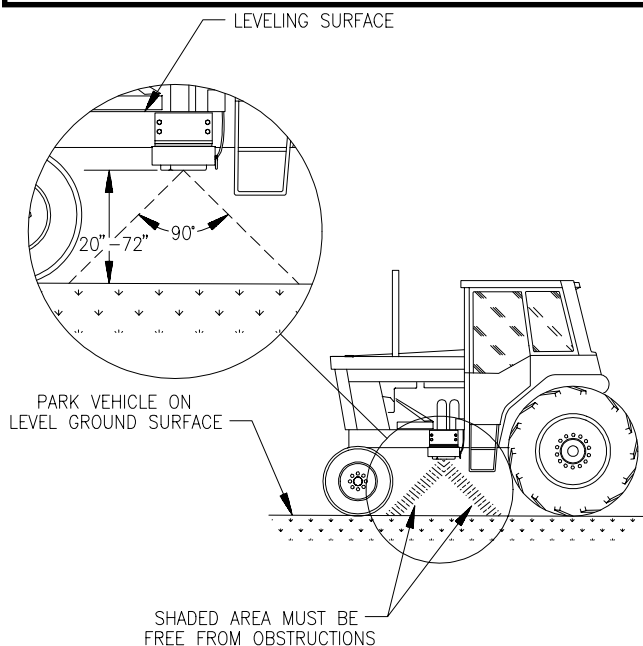

FIGURE 1

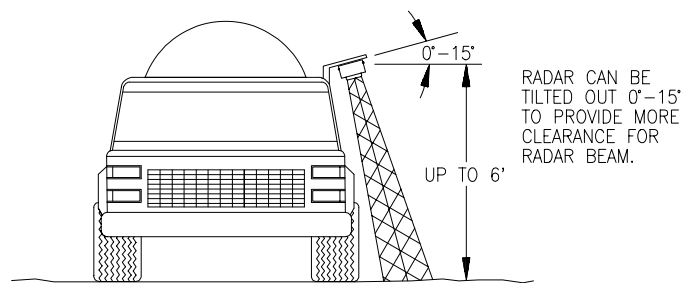

FIGURE 2

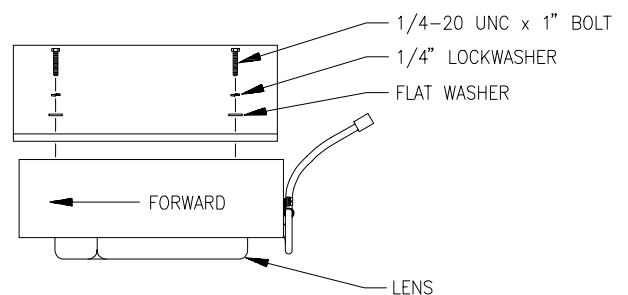

FIGURE 3

2. MOUNTING THE FLOW METER

- 1) Mount Flow Meter in the area of the boom valves per **Figure 4**. All flow through Flow Meter must go to booms only, i.e., no return line to tank or pump after Flow Meter.
- 2) Mount Flow Meter horizontal to the ground. Use the bracket to secure the Flow Meter.
- 3) For best results, allow a minimum of 7 1/2 inches [20 cm] of straight hose on inlet of Flow Meter. Bend radius of hose on outlet of Flow Meter should be gradual.
- 4) Flow must be in direction of arrow on Flow Meter.

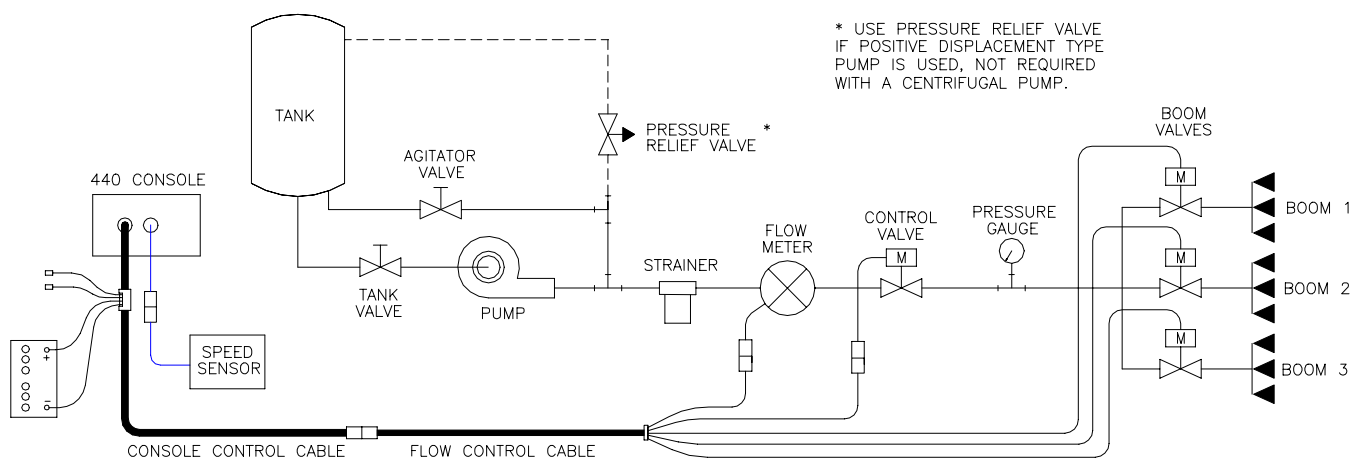

FIGURE 4

NOTE: It is essential, when using suspensions, that the system be thoroughly rinsed out each day after use.

3. MOUNTING THE CONTROL VALVE

- 1) Mount the motorized Control Valve in the main hose line between the Flow Meter and the booms, with motor in the upright position. (For flow less than 3 GPM [11 lit/min] the motorized Control Valve is mounted in a by-pass line. Refer to Appendix 3 for alternate plumbing diagram).
- 2) Connect the Flow Control Cable connectors to boom valves, Flow Meter, and motorized Control Valve. (Black wire to boom valve #1, Brown wire to boom valve #2 and Blue wire to boom valve #3).

4. MOUNTING THE CONSOLE AND CABLING

- 1) Mount the Console to a secure support inside the cab of the vehicle.
- 2) Connect the Console Control Cable to the plug in the back of the Console. (Reference [Figure 5](#)). Route the Console Control Cable out of the vehicle cab and terminate. (Flow Meter extension cables are available from your Dealer).

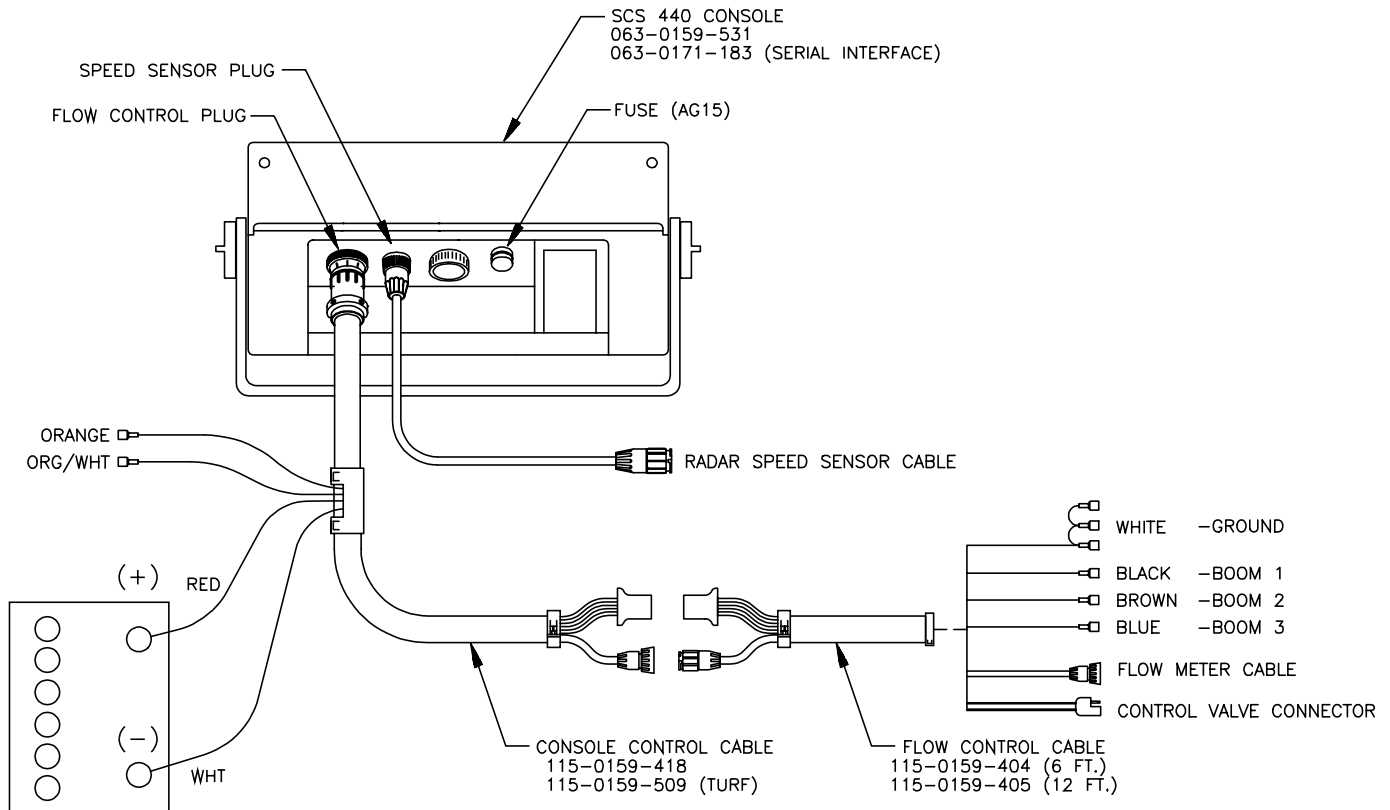

FIGURE 5

- 3) Turn POWER ON/OFF switch OFF and route the Red and White battery wires to a 12-volt battery. Attach the White battery wire to the **NEGATIVE** (-) terminal and the Red battery wire directly to the **POSITIVE** (+) battery terminal. (See [Figure 6](#)). **(DO NOT CONNECT RED AND WHITE WIRES TO THE STARTER)**. Secure the battery wires with plastic cable ties. **DO NOT** tie the battery wires close to the existing battery leads or any other electrical wiring.
- 4) Connect the Speed Sensor Cable to the plug in the back of the Console.
- 5) Secure and tie the Speed Sensor Cable and the Console Control Cable with plastic cable ties.
- 6) Initial installation of the system is now complete.

BATTERY CONNECTIONS

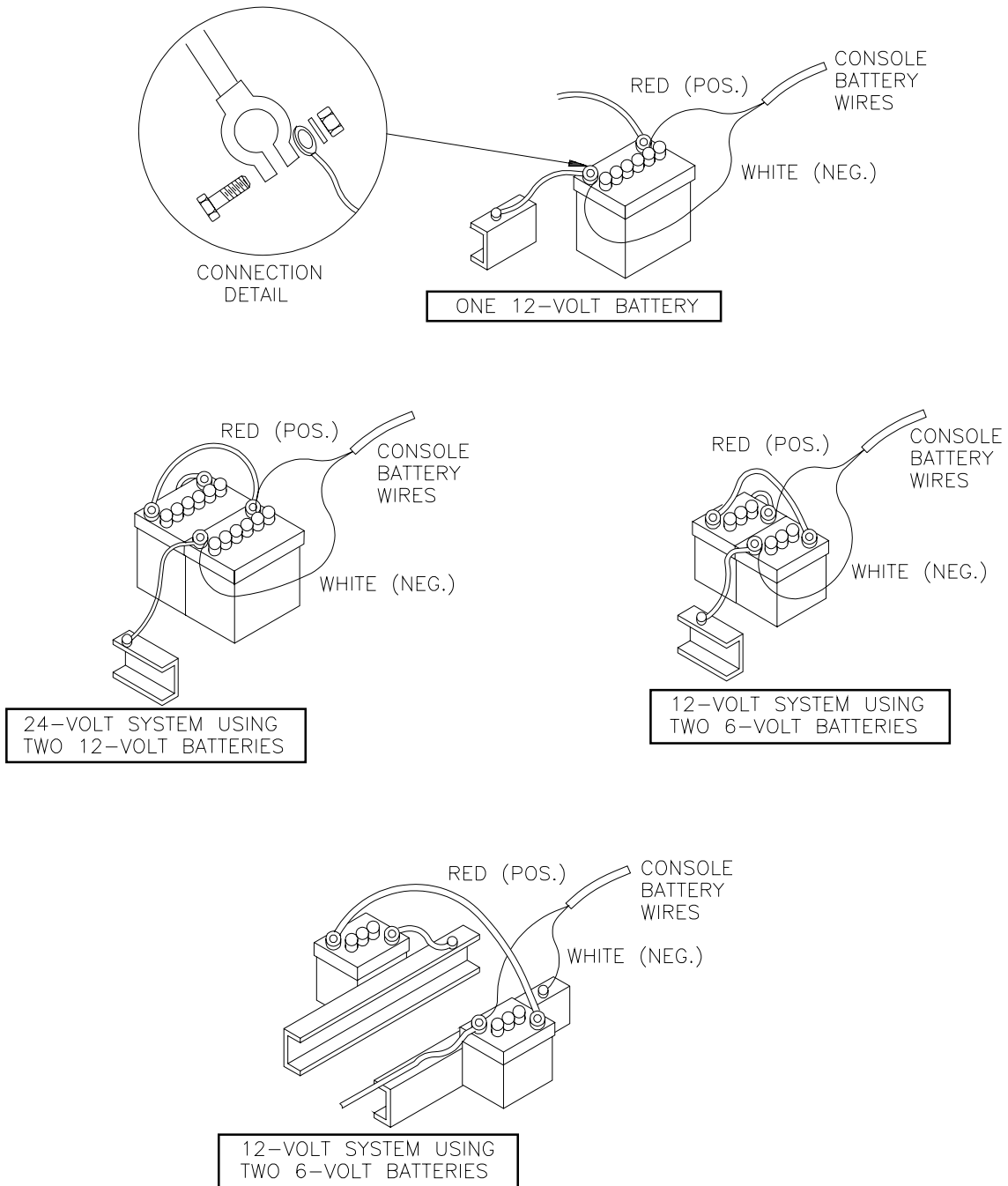
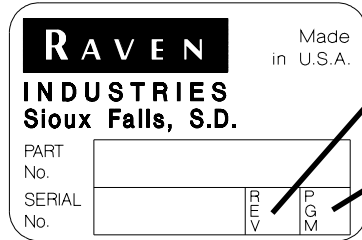

FIGURE 6

CONSOLE FEATURES

IMPORTANT: This Console requires selection of **US** (acres), **SI** [hectares], or **TU** {1,000 sq. ft.} area; **SP1** (wheel drive, etc.) or **SP2** (radar) speed sensor; and **C-sd** (Standard Valve) or **C-FC** (Fast Close Valve). Hold SELF TEST key to view selections.



Console Revision can be determined by the letter stamped in REV box on label.

Console Program can be determined by the letter stamped in PGM box on label.

Selects manual or fully automatic control.

Booms can be controlled individually, or all at once with MASTER ON/OFF switch.

Manual override control provides capability for spot spraying.

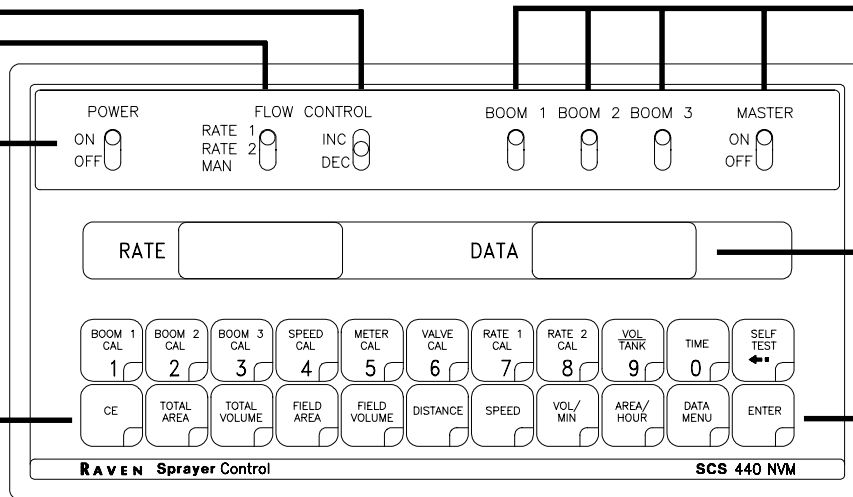

CE -Use like you do the CE key on a calculator.

ENTER -Used only to enter data into the Console.

Selects POWER ON or OFF.

Displays actual rate of application, calibration, and function data.

CALIBRATION KEYS -- Used to enter data into the Console to calibrate the system.

FUNCTION KEYS -- Used to Display Data

- BOOM 1 CAL -- Length of Boom 1
- BOOM 2 CAL -- Length of Boom 2
- BOOM 3 CAL -- Length of Boom 3
- SPEED CAL -- Determined by Speed Sensor
- METER CAL -- Meter Calibration Number
- VALVE CAL -- Valve Response Time
- RATE 1 CAL -- Target Application Rate
- RATE 2 CAL -- Target Application Rate
- SELF TEST -- Simulates Vehicle Speed

- TOTAL AREA -- Total Area Applied
- FIELD AREA -- Field Area Applied
- FIELD VOLUME -- Volume Applied to Field
- DISTANCE -- Distance Traveled
- SPEED -- Speed of Vehicle
- VOLUME/TANK -- Volume Remaining in Carrier Tank
- TIME -- 24 Hour Clock (Military Time)
- DATA MENU -- Printer Option

CONSOLE CALIBRATION

1. CALCULATING "BOOM CAL"

1) Broadcast Spraying

Calculate the width of each boom in inches [cm] by multiplying the number of tips times the spacing. Write these boom widths down for future reference when programming the Console.

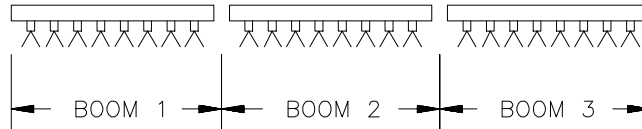

FIGURE 7

2) Band Spraying

Calculate the width of each boom in inches [cm] by multiplying the number of tips by the spacing. Calculate the Adjusted Applied Rate by multiplying the Broadcast Rate by Band Width in inches [cm] divided by Spacing in inches [cm].

EXAMPLE: Broadcast Rate = 20 GPA [200 lit/ha]
Spacing = 40 inches [100 cm]
Band Width = 14 inches [40 cm]

$$\begin{aligned} \text{Adjusted Applied Rate} &= \frac{\text{GPA} \times \text{Band Width}}{\text{Spacing}} \\ &= \frac{20 \times 14}{40} = 7 \text{ GPA} \\ &= \frac{[200] \times [40]}{[100]} = [80 \text{ lit/ha}] \end{aligned}$$

2. CALCULATING "SPEED CAL"

Initial SPEED CAL is 598 [152]. Complete **Steps 1 thru 6** to refine this number **after** "INITIAL CONSOLE PROGRAMMING" has been completed.

- 1) Set POWER switches to ON, all other switches to OFF.
- 2) Enter "0" in 
- 3) Drive 1 mile [1 kilometer]. To achieve the most accurate calibration, accelerate and decelerate slowly.

CAUTION: Do not use vehicle odometer to determine distance. Use section lines or highway markers.

- 4) Read DISTANCE by depressing .

DISTANCE should read a value of approximately 5280 [1000]. If it reads between 5260-5300 [990-1010], the SPEED CAL for the vehicle is 598 [152]. If the DISTANCE display reads any other value, perform the following calculation:

EXAMPLE: Assume DISTANCE reads 5000 [980].

$$\text{Corrected SPEED CAL} = \frac{\text{Old SPEED CAL} \times 5280}{\text{DISTANCE}}$$

ENGLISH UNITS:
 $= \frac{598 \times 5280}{5000} = 631.48$

METRIC UNITS:
 $= \frac{[152] \times [1000]}{[980]} = [155]$

- 5) The number to enter for SPEED CAL is 631 [155].
- 6) Recheck the new SPEED CAL derived in Step 5 by repeating Steps 2 thru 5.

3. CALCULATING "METER CAL"

The Flow Meter calibration number is stamped on the tag attached to each Flow Meter. Write down this number for future reference when programming the Console.

4. CALCULATING "VALVE CAL"

The initial Control Valve calibration number for VALVE CAL is 2123 for C-Sd (standard valve) or 743 C-FC (fast close valve). The VALVE CAL number is used to control response time of the Motor Control to the change in vehicle speed. After operating the system, this number maybe refined. See definitions below:

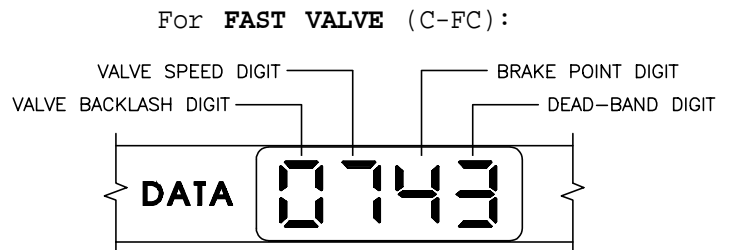
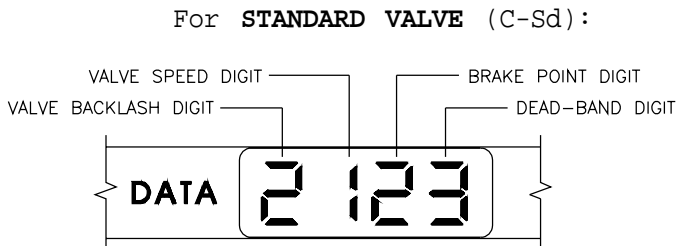

Valve Backlash Digit

Controls the time of the first correction pulse after a change in correction direction is detected. (INC to DEC -or- DEC to INC).

Range: 1 to 9 1-Short Pulse
 9-Long Pulse

Valve Speed Digit

Controls response time of Control Valve motor.

CAUTION: Running the Control Valve too fast will cause the system to oscillate.

C-Sd Valve Control

Range: 1 to 9 1-Slow
 9-Fast

C-FC Valve Control

Range: 0 to 9 0-Fast
 9-Slow

Brake Point Digit

Sets the percent away from target rate at which the Control Valve motor begins turning at a slower rate, so as not to overshoot the desired rate.

Range: 0 to 9 0 = 5%
 1 = 10%
 9 = 90%

Dead-Band Digit

Allowable difference between target and actual application rate, where rate correction is not performed.

Range: 1 to 9 1 = 1%
 9 = 9%

5. CALCULATING "RATE 1 AND RATE 2 CAL"

Determine the application rate at which chemical is to be sprayed. Consult with a Dealer to ensure these spray nozzles are capable of applying at this rate. In determining which spray nozzles to use with the sprayer the following must be known:

- 1) Nominal Application Pressure _____ PSI [kpa]
- 2) Target Application Rate _____ GPA [lit/ha]
- 3) Target Speed _____ MPH [km/h]
- 4) Nozzle Spacing _____ inches [cm]

From this information, calculate the volume per minute, per nozzle as follows:

$$\text{GPM [lit/min]} = \frac{\text{GPA [lit/ha]} \times \text{MPH [km/h]} \times \text{inches [cm]}}{5,940 [60,000]}$$

- EXAMPLE:**
- 1) Application Pressure = 30 PSI
 - 2) Target Application Rate = 20 GPA
 - 3) Target Speed = 5.2 MPH
 - 4) Nozzle Spacing = 20 inches

$$\text{GPM} = \frac{20 \text{ GPA} \times 5.2 \text{ MPH} \times 20 \text{ inches}}{5,940} = .35$$

Using GPM .35 and pressure 30 select tip number XR8004 from the chart below, since it comes closest to providing the desired output.

TIP COLOR	TIP NO.		LIQUID PRESSURE IN PSI	CAPACITY 1 NOZZLE IN GPM	CAPACITY 1 NOZZLE IN OZ/MIN	GALLONS PER ACRE 20" SPACING			
	80 DEG.	110 DEG.				5 MPH	6 MPH	7 MPH	8 MPH
YELLOW	XR8002	XR11002	15	.12	15	7.3	6.1	5.2	4.5
			20	.14	18	8.4	7.0	6.0	5.3
			30	.17	22	10.3	8.6	7.4	6.4
			40	.20	26	11.9	9.9	8.5	7.4
			60	.25	32	14.6	12.1	10.4	9.1
BLUE	XR8003	XR11003	15	.18	23	10.9	9.1	7.8	6.8
			20	.21	27	12.6	10.5	9.0	7.9
			30	.26	33	15.4	12.9	11.0	9.7
			40	.30	38	17.8	14.9	12.7	11.1
			60	.37	47	22.0	18.2	15.6	13.6
RED	XR8004	XR11004	15	.24	31	14.5	12.1	10.4	9.1
			20	.28	36	16.8	14.0	12.0	10.5
			30	.35	45	21.0	17.2	14.7	12.9
			40	.40	51	24.0	19.8	17.0	14.9
			60	.49	63	29.0	24.0	21.0	18.2
BROWN	XR8005	XR11005	15	.31	40	18.2	15.2	13.0	11.4
			20	.35	45	21.0	17.5	15.0	13.1
			30	.43	55	26.0	21.0	18.4	16.1
			40	.50	64	30.0	25.0	21.0	18.6
			60	.61	78	36.0	30.0	26.0	23.0

VERIFYING FLOW RATE LIMITS:

The flow rate of spraying must be within the range of that specified for the Flow Meter included.

FLOW METER MODEL

RFM 5
 RFM 15
 RFM 55/55A
 RFM 100
 RFM 200/200 Poly
 RFM 400

FLOW RANGE

0.05-5 GPM [0.2-18.9 lit/min]
 0.3-15 GPM [1.1-56.8 lit/min]
 1-55 GPM [3.8-208 lit/min]
 3-100 GPM [11.4-379 lit/min]
 15-200 GPM [56.8-757 lit/min]
 25-400 GPM [94.6-1514 lit/min]

CONSOLE PROGRAMMING

When entering data into the Console, the entry sequence is always the same.

NOTE: DATA MUST BE ENTERED INTO KEYS 1 THRU 8.

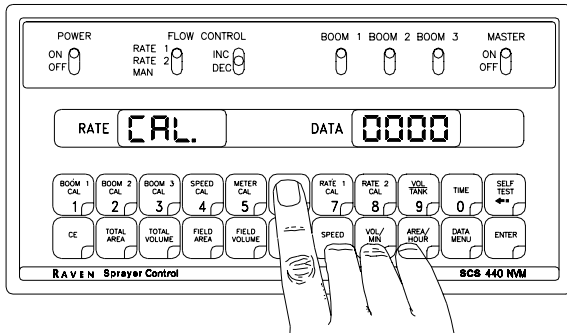

Depress the key in which you wish to enter data.

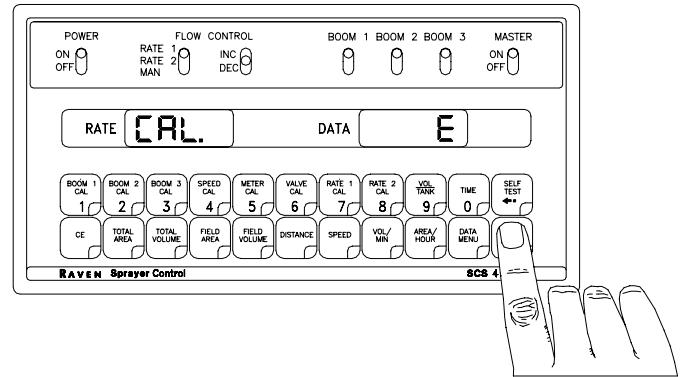

Depress the ENTER key. An "E" will illuminate in the DATA display.

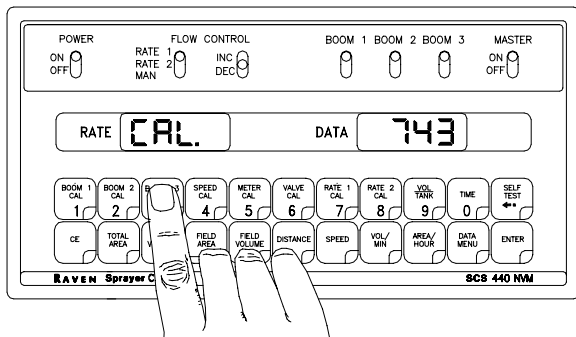

Depress the keys corresponding to the number you wish to enter (i.e. "7", "4", "3"). The numbers will be displayed as they are entered.

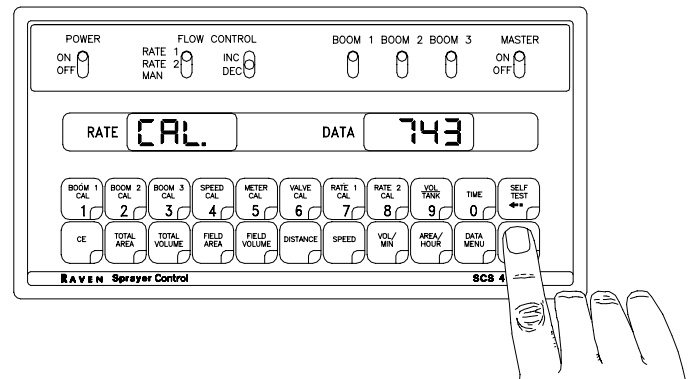



Complete the entry by again depressing the ENTER key.



1. INITIAL CONSOLE PROGRAMMING



When Console power is turned on, after all installation procedures have been completed, the Console will flash "CAL" in the RATE display. This means the console must be "calibrated", or programed, before it can be operated. This is a one-time operation which does not have to be repeated. Turning OFF the POWER ON/OFF switch does not affect the Console memory. All data is retained.



IMPORTANT: If an entry selection error is made during Steps 1-6, place the POWER ON/OFF switch to OFF. Depress  and hold while placing the POWER ON/OFF switch to ON. This will "reset" the Console.













The DATA display will show "US", and the RATE display will show "CAL". The following Steps must be followed:

- 1) Display US (acres), SI [hectares], or TU {1000 sq. ft.}.
 - a) Depressing momentarily  steps the DATA display from US to SI.
 - b) Depressing momentarily  steps the DATA display from SI to TU.
 - c) Depressing momentarily  steps the DATA display from TU to US.

- 2) Selecting US, SI, or TU.
 - a) To select US, SI, or TU, step  until the desired code is displayed.
 - b) Momentarily depress , the DATA display will now display SP1.

- 3) Display SP1 (wheel drives, etc.) or SP2 (radar sensor).
 - a) Depressing momentarily  steps the DATA display from SP1 to SP2.
 - b) Depressing momentarily  steps the DATA display from SP2 to SP1.

- 4) Selecting SP1 or SP2.
 - a) To select SP1 or SP2, step  until desired code is displayed.
 - b) Momentarily depress , the DATA display will now display C-Sd.



- 5) Display C-Sd (Standard Valve) or C-FC (Fast Close Valve).
- a) Depressing momentarily  steps the DATA display from C-Sd to C-FC.
- b) Depressing momentarily  steps the DATA display from C-FC to C-Sd.
- 6) Selecting C-Sd or C-FC.
- a) To select C-Sd or C-FC, step  until desired code is displayed.
- b) Momentarily depress , the DATA display will now display "0".
- 7) Enter width in inches [cm] of BOOM 1 in the .
- 8) Enter width in inches [cm] of BOOM 2 in .
- If there is only one boom, enter a "0" for width of BOOM 2.
- 9) Enter width in inches [cm] of BOOM 3 in .
- If there is only one or two booms, enter a "0" for width of BOOM 3.
- 10) Enter SPEED CAL calibration number in .
- 11) Enter the METER CAL calibration number in .
- 12) Enter VALVE CAL calibration number (2123 or 743) in .
- 13) Enter the target RATE 1 (GPA) [lit/ha] {GPK} in .
- 14) Enter the target RATE 2 (GPA) [lit/ha] {GPK} in .
- (If a second rate is not used, enter the same rate as RATE 1 CAL).

NOTE: RATE 2 should not be more than 20% different from RATE 1 or else spray pattern may suffer.

PROGRAMMING THE CONSOLE IS NOW COMPLETED.

The flashing "CAL" will now extinguish. If not, repeat procedure starting at Step 7.

ENTERING ADDITIONAL DATA:

Data may be entered in the  and  although it is not required for the operation of the system.

1) ENTERING VOLUME:

Enter the estimated VOLUME in the TANK in . Each time the tank is refilled, this number must be re-entered.

2) ENTERING TIME, DATE, AND POWER DOWN:

Definition of Time, Date, and Power Down Key:

 Depressing this key displays selected Time features in DATA display.
EXAMPLE: RATE display will display "TInE" and DATA will display 0:00.

 Depressing this key again after selecting TIME increments through desired features.
EXAMPLE: TIME, MONTH, DAY, YEAR, and POWER DOWN.

3) Enter TIME

- a) Select TIME
- b) Enter TIME when RATE display shows "TInE".

4) Enter MONTH

- a) Select MONTH
- b) Enter MONTH when RATE display shows "OnTH".

5) Enter DAY

- a) Select DAY
- b) Enter DAY when RATE display shows "dAY"

6) Enter YEAR









- a) Select YEAR
- b) Enter YEAR when RATE display shows "YEAr"

7) POWER DOWN FEATURE



If the Console is not used for 10 days, it will go into a power down (low power) mode of operation. In this mode, all data will be retained, but the time of day clock will reset to 0:00. The delay time is initially set at 10 days, but can be changed by the user.

- a) Enter POWER DOWN
 - 1) Select POWER DOWN
 - 2) Enter POWER DOWN when RATE display shows "Pdn".

2. OTHER DISPLAY FEATURES

- 1) To display TOTAL AREA covered, momentarily depress .
To "zero out" this total at any time, enter a "0" in this key.
- 2) To display TOTAL VOLUME sprayed, momentarily depress .
To "zero out" this total at any time, enter a "0" in this key.
- 3) To display FIELD AREA covered, momentarily depress .
To "zero out" this total at any time, enter a "0" in this key.
- 4) To display FIELD VOLUME sprayed, momentarily depress .
To "zero out" this total at any time, enter a "0" in this key.
- 5) To display DISTANCE (feet) [meters] traveled, momentarily depress . To "zero out" this total at any time, enter a "0" in this key.
- 6) To display SPEED, momentarily depress .
- 7) To display VOL/MIN, momentarily depress .
- 8) To display AREA/HOUR, momentarily depress . This is an actual calculation of AREA/HOUR at the present speed you are going. It is not an average over a period of time.
- 9) To display US, SI, or TU; SP1 or SP2; and C-Sd or C-FC after being selected, depress .

3. SELF TEST FEATURE

SELF-TEST allows speed simulation for testing the system while vehicle is not moving. Enter the simulated operating speed in . If 6 MPH [10 km/h] is desired, enter 6.0 [10.0]. Verify SPEED by depressing . The SELF-TEST speed will clear itself when motion of vehicle is detected by the Speed Sensor. A SPEED CAL value of 900 [230] or greater is recommended when operating in this mode.

NOTE: To prevent nuisance clearing of self-test speed, disconnect speed connector on back of Console when Radar Speed Sensors are used.

4. VOLUME/MINUTE RATE FAULT

Depress  until DATA display flashes. A low limit flow rate may now be entered.

If the actual volume per minute falls below this limit, the Control Valve stops closing, an alarm sounds, and the display flashes "-LL-". The low limit value should be determined with all booms ON. This value is automatically proportional to the percentage of booms that are ON. (i.e. If the entered low limit is 4 and half the total boom length is shut off, the Console automatically reduces the low limit to 2).

NOTE: Go to DATA MENU to silence alarm.

5. VOLUME/AREA RATE ALARM



Console alarm sounds if the application rate is 30% or more away from the target application rate for more than 5 seconds.

NOTE: Go to DATA MENU to silence alarm.

6. LOW TANK FAULT

This feature will sound the alarm when the volume in the tank drops below an entered value. The alarm will intermittently beep every 15 seconds and the RATE display will flash "LEVL". The alarm will stop when a value equal to or greater than the LOW TANK ALARM is entered into VOL/TANK or the booms are turned OFF. Entering "0" into LOW TANK ALARM disables it.

To select LOW TANK ALARM depress  until DATA display flashes. To enter value

depress , then LOW TANK ALARM value, and .

NOTE: Go to DATA MENU to silence alarm.

7. AUTOMATIC RATE +/-



This feature sets the increment at which flow is increased or decreased in RATE 1 or RATE 2 operation. Enter rate change value by depressing  until DATA

display flashes. To enter a value depress , then the increment value, and

.





EXAMPLE: If rate is to change by "1.0":
Enter a value of 1.0 for RATE +/- . When in RATE 1 or RATE 2, each time the INC/DEC switch is positioned to INC the RATE CAL for that rate will increase by "1.0". Likewise, when positioned to DEC the RATE CAL will decrease by "1.0".

8. CONTROL VALVE DELAY







Depress  until DATA display flashes. The first digit, (), is the Control Valve delay digit. This feature allows the user to set a delay between the time the booms are turned ON and when the Console begins to control the flow rate. A value of 1-9 means a delay of 1-9 seconds respectively. A value of 0 means no delay. This delay is active if the time between turning OFF and turning ON the booms is less than 30 seconds.

9. SEQUENCE TO ACTIVATE DATA-LOCK





- 1) Depress  for 5 seconds, NEW CODE message will appear.
- 2) Enter 4 digit code within 15 seconds.

EXAMPLE: For 1058, depress     and .

10. SEQUENCE TO CHANGE DATA-LOCK



- 1) Depress  for 5 seconds, OLD CODE message will appear.
- 2) Enter 4 digit code within 15 seconds     and .

NEW CODE message will appear. Enter 4 digit code within 15 seconds.

EXAMPLE: For 1582, depress     and .

11. ENTER MODE SEQUENCE WITH ACTIVATED DATA-LOCK

The DATA-LOCK feature prohibits the entry of data without first entering the DATA-LOCK CODE. If DATA-LOCK is not desired, omit Steps 9, 10, and 11.

- 1) Depress the key in which data is to be entered.
- 2) Depress . CODE message will appear. Enter the DATA-LOCK CODE. If CODE is correct, "E" will appear. Now enter data normally.
- 3) The DATA-LOCK CODE may be cleared by entering a code of "0" or by resetting the Console. To RESET Console place POWER ON/OFF switch to OFF, depress  and hold while placing the POWER ON/OFF switch to ON.

12. DATA MENU

The following are brief descriptions of features available under the DATA MENU key (some features are only available on consoles with serial interface port):

DISPLAY		
<u>RATE</u>	<u>DATA</u>	<u>FEATURE and DESCRIPTION</u>
Prn	bEGn	CONSOLE DATA PRINTOUT Sends data through serial port to attached optional printer to print field begin and field end pages (Serial interface console only).
ALrn	on	AUDIBLE ALARMS ON/OFF Turns audible alarms ON or OFF for the following: 1) Volume/Area Rate Alarm 2) Volume/Minute Rate Fault 3) Low Tank Fault
diSP	on	DISPLAY SMOOTHING ON/OFF Turns display smoothing ON or OFF. Selecting display smoothing ON means the RATE window displays target rate when actual rate is within a percentage of target rate. The third digit of VALVE CAL determines this percentage.
rATE	on	RATE CHANGE ALARM ON/OFF Turns rate change alarm ON or OFF. When rate change alarm is selected ON; alarm sounds 4 long beeps when the rate 1 calibration number is changed via the serial port using a valid change request data string (Serial interface console only).
FILE	1	GPS FILE REFERENCE Used only with Raven Grid Application System. See Grid Application System manual for more details (Serial interface console only).
GPS	InAC	GPS OPTIONS Used only with Raven Grid Application System. See Grid Application System manual for more details (Serial interface console only).
FrEF	0	FIELD REFERENCE Allows user to enter up to a four-digit number to represent a field. Field reference is included in field begin and field end pages and the data logger time/date string (Serial interface console only).

DISPLAY

<u>RATE</u>	<u>DATA</u>	<u>FEATURE and DESCRIPTION</u>
bAUd	1200	BAUD RATE Used in GPS mode and data logging mode. Selectable between 1200 or 9600 baud (Serial interface console only).
TriG	0	DATA LOGGER TRIGGER VALUE Used in data logging mode. The trigger determines how often actual rate data string (See Appendix 10 for data communication string formats) is sent to the serial port. The trigger may be either feet [meters] or seconds (Serial interface console only).
UniT	FT	DATA LOGGER TRIGGER UNITS Used in data logging mode. The trigger unit is selectable between feet [meters] or seconds (Serial interface console only).
dLoG	oFF	DATA LOGGER ON/OFF Turns data logger ON or OFF (Serial interface console only).

1) Definition of Data Menu Key:



Depressing this key displays selected Data Menu features in RATE display. **EXAMPLE:** RATE display will display options by name and DATA will display default setting.



Depressing this key after selecting DATA MENU increments through desired features. **EXAMPLE:** "Prn" "bEGn", "ALrn"on", "diSP"on", etc....

2) CONSOLE DATA PRINTOUT

a) RATE display will show "Prn". DATA display will show "bEGn" (Print Field Begin).

1) To Print Field Begin, depress .



b) RATE display will now show "Prn" and DATA display will show "End" (Print Field End).

1) To Print Field End, depress .

2) While "End" is displayed, if Field Begin is required, depress 
to toggle DATA display to "bEGn".

c) Momentarily depress  to advance to AUDIBLE ALARM ON/OFF.

3) AUDIBLE ALARM ON/OFF

- a) RATE display will show "ALrn". DATA display will show "on".
- b) Depressing  momentarily changes the DATA display between "on" and "off". A value of "on" means the audible alarms are enabled; a value of "off" means the audible alarms are disabled.
- c) Momentarily depress  to advance to DISPLAY SMOOTHING ON/OFF.

4) DISPLAY SMOOTHING ON/OFF

- a) RATE display will show "diSP". DATA display will show "on".
- b) Depressing  momentarily changes the DATA display between "on" and "oFF". A value of "on" means smoothing is enabled; a value of "oFF" means smoothing is disabled. The percent smoothing is determined by the third digit of VALVE CAL value as shown:



Brake Point Digit
(3rd digit) of VALVE CAL 2 1 2 3

0 = 1% + Deadband	5 = 25% + Deadband
1 = 3% + Deadband	6 = 30% + Deadband
2 = 7% + Deadband	7 = 35% + Deadband
3 = 10% + Deadband	8 = 40% + Deadband
4 = 20% + Deadband	9 = 45% + Deadband

Actual rate is displayed if unit does not reach deadband within 10 seconds. "oFF" means RATE displays the actual rate at all times.

- c) Momentarily depress  to advance to RATE CHANGE ALARM ON/OFF.

5) RATE CHANGE ALARM ON/OFF

- a) RATE display will show "rATE". DATA display will show "on".
- b) Depressing  momentarily changes the DATA display between "on" and "oFF". A value of "on" means alarm is enabled; a value of "oFF" means alarm is disabled.
- c) Momentarily depress  to advance to GPS FILE REFERENCE.

6) GPS FILE REFERENCE

- a) RATE display will show "FILE". DATA display will show a "1".
- b) Enter the GPS file number.
- c) Momentarily depress  to advance to GPS OPTIONS.

7) GPS OPTIONS

a) GPS is inactive when the RATE display shows "GPS" and the DATA display shows "InAC". The GPS features are explained further in the GRID APPLICATION SYSTEM MANUAL.

b) Momentarily depress  to advance to FIELD REFERENCE.

8) FIELD REFERENCE

a) RATE display will show "FrEF". DATA display will show "0".

b) Enter the field number.

c) Momentarily depress  to advance to BAUD RATE.

9) BAUD RATE

a) RATE display will show "bAUd". DATA display will show "1200".

b) Depressing  momentarily changes the DATA display between "1200" and "9600".

c) Momentarily depress  to advance to DATA LOGGER TRIGGER VALUE.

NOTE: The TRIGGER VALUE default value is "zero". This value must be changed to a desired number ranging from 1-9999. The DATA LOGGER features will not work if this number is not changed.

10) DATA LOGGER TRIGGER VALUE

a) RATE display will show "TriG". DATA display will show "0".

b) Enter the TRIGGER VALUE.

c) Momentarily depress  to advance to DATA LOGGER TRIGGER UNITS.

11) DATA LOGGER TRIGGER UNITS

a) RATE display will show "UniT". DATA display will show "FT"["nETr"].

b) Depressing  momentarily changes the DATA display between "FT" [nETr] and "SEC". A value of "FT"["nETr"] means feet [meters], or a value of "SEC" means seconds has been chosen as the unit of measurement for the TRIGGER VALUE programmed previously.

c) Momentarily depress  to advance to DATA LOGGER.

12) DATA LOGGER ON/OFF

- a) The DATA LOGGER uses the communications strings listed in Appendix 10 to pass data out through the serial port. The data is sent at a set time interval or a set distance traveled, as determined by the values entered in the DATA LOGGER TRIGGER VALUE and DATA LOGGER TRIGGER UNITS. Upon each trigger, the Actual Rate string, Data Strings 1, 2, and 3, and the Time/date string are sent, in that order. When a Console calibration value is changed, the Console will automatically send out the Cal 1, 2, and 3 strings. When a Console switch is changed, the Data 1, 2, 3, Time/Date, and Cal 1, 2, 3 strings will be sent by the Console. The Data, (with Time/Date string included) and Cal strings can also be requested by the data logger using the request strings shown in Appendix 10.

NOTE: Some options within the DATA MENU LISTINGS may be unavailable if certain features are on or active. The options affected are:

CONSOLE DATA PRINTOUT: Console Data Printout will not be available when DATA LOGGER is ON or when GPS functions are ACTIVE.

GPS OPTIONS: GPS Options will not be available when DATA LOGGER is ON.

DATA LOGGER: DATA LOGGER will not be available when GPS functions are active.

- b) RATE display will show "dLOG". DATA display will show "oFF".

- c) Depressing  momentarily changes the DATA display between "oFF" and "on". A value of "oFF" means DATA LOGGER is disabled; a value of "on" means DATA LOGGER is enabled.

- d) Momentarily depress  to advance to CONSOLE DATA PRINTOUT.

13. DECIMAL SHIFT

The DECIMAL SHIFT feature is used to increase system accuracy at low application rates. Shifting of the decimal point is done during the entry of METER CAL. After

entering METER CAL mode, depress the decimal shift , enter the meter

calibration constant number, and depress . The sequence to unshift the

decimals while in METER CAL is to enter the meter calibration constant number and

depress . The following table illustrates how shifting the decimal point

can increase system accuracy.

DECIMAL PLACE LOCATIONS

	<i>US</i>		<i>METRIC</i>		<i>TURF</i>	
	<i>UNSHIFT</i>	<i>SHIFT</i>	<i>UNSHIFT</i>	<i>SHIFT</i>	<i>UNSHIFT</i>	<i>SHIFT</i>
RATE DISPLAY	000.0	00.00	0000	000.0	00.00	00.00
RATE 1 CAL	000.0	00.00	0000	000.0	00.00	00.00
RATE 2 CAL	000.0	00.00	0000	000.0	00.00	00.00
TANK VOLUME	0000	000.0	0000	000.0	000.0	000.0
TOTAL AREA	000.0	000.0	000.0	000.0	0000	0000
TOTAL VOLUME	0000	000.0	0000	000.0	000.0	000.0
FIELD AREA	000.0	000.0	000.0	000.0	0000	0000
FIELD VOLUME	0000	000.0	0000	000.0	000.0	000.0
VOL/MINUTE	0000	000.0	0000	000.0	000.0	000.0
AREA/HOUR	000.0	000.0	000.0	000.0	0000	0000
RATE +/-	000.0	00.00	0000	000.0	00.00	00.00
LOW TANK LEVEL	0000	000.0	0000	000.0	000.0	000.0
LOW VOL/MIN	0000	000.0	0000	000.0	000.0	000.0

When entering RATE 1 CAL and RATE 2 CAL, remember that 2 GPA [20 lit/ha] is entered as 2.0 [20.0] when unshifted and 2.00 [20.00] when shifted.

INITIAL SYSTEM SET-UP

- 1) Fill tank with water only. (If positive displacement pump is used, open pressure relief valve, PRV).
- 2) Place MASTER ON/OFF switch to ON and BOOM ON/OFF switches to OFF.
- 3) Place RATE 1/RATE 2/MAN switch to MAN.
- 4) Place POWER ON/OFF switch to ON.
- 5) Verify that Boom Widths, SPEED CAL, METER CAL, VALVE CAL, and RATE CALS have been entered correctly into the Console. In SELF TEST mode, enter the normal sprayer operating speed.
- 6) Run pump at normal operating RPM.
- 7) If centrifugal pump is used, proceed with [Step 8](#). If positive displacement pump is used, set pressure relief valve (PRV) to 65 PSI [450 kPa].
- 8) Verify that boom valves operate and that no nozzles are plugged by operating the BOOM ON/OFF switches.
- 9) Place all BOOM ON/OFF switches to ON.
- 10) Hold the FLOW CONTROL switch in INC position until pressure is at its maximum. This assures that the motorized Control Valve is fully open. Verify maximum pressure and RATE. (Pressure gauge is not supplied).

NOTE: A pressure gauge MUST be installed to properly monitor the system.

- 11) Adjust agitator line hand valve for desired agitation. Verify maximum pressure is still present.
- 12) Hold the FLOW CONTROL switch to DEC position until pressure is at its minimum. This assures that the motorized Control Valve is fully closed. Verify minimum pressure and RATE. If minimum pressure and RATE can not be obtained, consider by-pass plumbing system in [Appendix 3](#).

INITIAL SYSTEM FIELD TEST

- 1) Drive down field or road at target speed with sprayer booms off, to verify SPEED readout on Console.
- 2) Turn on sprayer and booms and place the RATE 1/RATE 2/MAN switch to RATE 1. Increase or decrease speed by one MPH [2 km/h]. The system should automatically correct to the target application rate.
- 3) If for any reason, the system is unable to correct to the desired RATE, check for an empty tank, a plugged line, a malfunctioning pump, improper vehicle speed, or a defect in the system.
- 4) If the system does not appear to be correcting properly, first review INITIAL SYSTEM SET-UP, then refer to TROUBLESHOOTING GUIDE.
- 5) At the end of each row, switch the MASTER ON/OFF to OFF to shut off flow. This also shuts off the area totalizer.
- 6) Verify area covered and volume used.

PREVENTIVE MAINTENANCE

Preventive maintenance is most important to assure long life of the system. The following maintenance procedures should be followed on a regular basis:

- 1) Flush entire system with water after use of suspension type chemicals. Failure to clean system can result in crystallization of chemicals which may plug the Flow Meter, lines, and/or tips.
- 2) Flush and drain Sprayer before storing. **FREEZING TEMPERATURES MAY DAMAGE FLOW METER IF WATER IS NOT DRAINED.**
- 3) Remove Flow Meter at the end of each spraying season. Clean Flow Meter turbine and inlet hub. Clean off all metal filings and wetttable powders which have hardened on the plastic and metal parts. Check the inlet hub and turbine assembly for worn or damaged turbine blades and bearings. Flush Flow Meter with clear water and drain.

KEEP FROM FREEZING

- 4) Remove Console when not in use for extended periods.

TROUBLESHOOTING GUIDE

<u>PROBLEM</u>	<u>CORRECTIVE ACTION</u>
1) NO DISPLAY LIGHTS WITH POWER ON.	1) Check fuse on back of Console. 2) Check battery connections. 3) Check operation of POWER ON/OFF switch. 4) Return Console to your Dealer to replace Processor Board Assembly.
2) ALL KEYBOARD LIGHTS ON AT SAME TIME.	1) Return Console to your dealer to replace Face Plate Sub-assembly.
3) A DIGIT CANNOT BE ENTERED VIA KEYBOARD.	1) Return Console to your Dealer to replace Face Plate Sub-assembly.
4) AN INDICATOR LIGHT ON A KEY WILL NOT ILLUMINATE.	1) Return Console to your Dealer to replace Face Plate Sub-assembly and/or Processor Board Assembly.
5) CONSOLE DISPLAYS FLASHING "CAL" WHENEVER VEHICLE ENGINE IS STARTED.	1) Check battery voltage and battery connections.
6) CONSOLE DISPLAYS FLASHING "CAL" WHENEVER MASTER SWITCH IS TURNED ON OR OFF.	1) Check battery voltage and battery connections.
7) CONSOLE DISPLAYS FLASHING "CAL" WHENEVER SPEED IS CHANGED.	1) Check battery voltage and battery connections.
8) "TIME" FUNCTION IS INACCURATE OR DRIFTING.	1) Return Console to Dealer to replace Processor Board Assembly.
9) ONE DISPLAY DIGIT HAS ONE OR MORE MISSING SEGMENTS.	1) Return Console to Dealer to replace LCD Display Board Assembly.
10) SPEED DISPLAY "0".	1) Check Speed Sensor cable connector and plug on back of Console for loose pins. 2) Clean pins and sockets on Speed Sensor cable connectors. 3) If no extension cable is used, replace Speed Sensor Switch Assembly. 4) If Speed Sensor Extension Cable is used, see Appendix 4.
11) SPEED INACCURATE OR UNSTABLE (WHEEL DRIVE SPEED SENSOR).	1) Run speed check on hard surface road. If SPEED is accurate, investigate Speed Sensor on different wheel. (Cont. next page)

- 2) Remove one red magnet and one black magnet from the wheel. (Reposition remaining red and black magnets directly across from each other). Enter a SPEED CAL number in the Console twice as large as the correct SPEED CAL number. Run speed check on hard surface road. Remove these two magnets and replace with other two. Run speed check. If SPEED is inaccurate with only one set of magnets, replace the bad set. If SPEED is inaccurate with both sets, replace Speed Sensor Assembly.

NOTE: Re-enter original SPEED CAL number after testing is complete.

12) SPEED INACCURATE OR UNSTABLE (SPEEDOMETER DRIVE SPEED SENSOR).

- 1) Wiggle cable at the Speed Sensor connector. If speed is displayed, tighten connector or replace Transducer Assembly.
- 2) Check Speedometer Cable Adapter, Key, and Transducer Assembly for proper connections and engagement.
- 3) Check for kinked speedometer cable or too sharp of bend.
- 4) Replace Speedometer Transducer Assembly.

13) RATE READS "0000".

- 1) Verify SPEED is registering accurately. If SPEED is zero, refer to Troubleshooting Problem 10.
- 2) Verify TOTAL VOLUME is registering flow. If not, refer to Troubleshooting Problem 17.

14) RATE INACCURATE OR UNSTABLE.

- 1) Verify that all numbers "keyed in" Console are correct. Verify SPEED is registering accurately. If SPEED is inaccurate, refer to Troubleshooting Problem 11 or 12.
 - 2) In MAN (manual) operation, verify that RATE display (GPA) holds constant. If not, refer to Troubleshooting Problem 18.
 - 3) In MAN (manual) operation, check low end and high end pressure range. Pressure range must be per initial system set-up on page 26. If pressure cannot be adjusted manually, refer to Troubleshooting Problem 17.
- (Cont. next page)

- | | |
|---|---|
| 15) CAN NOT VARY RATE IN MANUAL OPERATION OR IN AUTO. | <ul style="list-style-type: none"> 4) If problem persists, return Console to Dealer to replace Processor Board Assembly. |
| 16) SPRAYER PRESSURE IS CORRECT BUT RATE IS LOW. | <ul style="list-style-type: none"> 1) Check cabling to motorized Control Valve for breaks. 2) Check connections in cabling for cleanliness. 3) Verify that there is voltage at the valve connector by placing MASTER switch ON; RATE 1/RATE 2/MAN switch to MAN; and POWER switch to ON. Manually operate INC/DEC switch to verify voltage. 4) Verify that valve is turning, if not, replace motorized Control Valve. |
| 17) TOTAL VOLUME DOES NOT REGISTER. | <ul style="list-style-type: none"> 1) Verify that nozzle strainer screens or check valves are not plugged. 2) Verify that pressure at each boom is the same. 3) Verify all nozzles are of proper and same orifice size. See Page 12 of Installation Manual. |
| 18) TOTAL VOLUME REGISTERS FLOW INACCURATELY. | <ul style="list-style-type: none"> 1) Check Flow Meter Cable for breaks and shorts. See Appendix 5 for test procedure. 2) Check internals of Flow Meter; clean and adjust. See Appendix 6 for Flow Meter cleaning and adjustments. 3) Replace Flow Meter Transducer. |
| 19) MOTORIZED CONTROL VALVE ROTATES MORE THAN 1/4 TURN. | <ul style="list-style-type: none"> 1) Verify that arrow on Flow Meter is pointing in direction of flow. See Appendixes 6 and 7. |
| 20) WATER INSIDE COVER OF MOTORIZED CONTROL VALVE. | <ul style="list-style-type: none"> 1) Replace motorized Control Valve. |
| 21) BOOM VALVE(S) WILL NOT OPERATE. | <ul style="list-style-type: none"> 1) Replace Isolation Flange Assembly and coupler shaft. 2) Replace entire motorized Control Valve, if PC board or motor is corroded and will not run. |
| 22) BOOM VALVE(S) WILL NOT OPERATE. | <ul style="list-style-type: none"> 1) Check cable for wires with breaks. 2) Check connectors for cleanliness. 3) Check BOOM switch and MASTER switch for operation. 4) Replace Boom Valves. |

APPENDIX 1

WHEEL DRIVE SPEED SENSOR INSTALLATION AND CALIBRATION PROCEDURE

1. MOUNTING WHEEL DRIVE SPEED SENSOR

The Wheel Drive Speed Sensor consists of four magnets, a switch assembly with cable, and mounting hardware.

Sequence of mounting Speed Sensor:

- 1) Select a non-driven wheel (left front tractor wheel or implement wheel).
- 2) Check for predrilled holes in rim. If not predrilled, see "RIM DRILLING INSTRUCTIONS FOR WHEEL DRIVE SPEED SENSOR".
- 3) Mount the four magnets to the inside of rim and tighten (See Figures below). Magnets must be mounted in alternating red-black order.
- 4) Mount switch assembly to stationary column with the hardware provided (See below). The switch assembly need not pivot with the wheel.

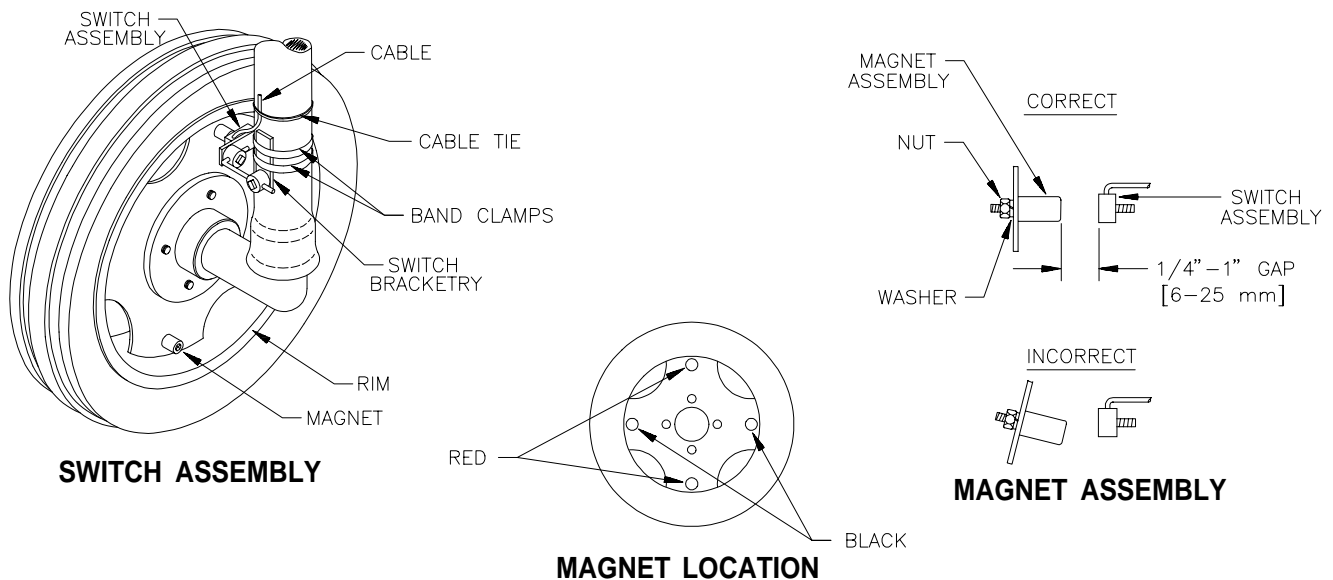

- 5) Position switch assembly so that as the wheel rotates the magnets pass across the center of the black, molded switch assembly.
- 6) Clearance gap between magnets and switch assembly must be between 1/4 inch [6 mm] and 1 inch [25 mm]. With wheels pointed straight ahead, rotate wheel to ensure gap is correct. Make sure vehicle wheels can be turned to their extremes in each direction without the magnets hitting the switch assembly.
- 7) Tighten switch assembly bracketry.
- 8) Secure cable to column with plastic cable ties.

2. RIM DRILLING INSTRUCTIONS FOR WHEEL DRIVE SPEED SENSOR MAGNETS

On wheels which do not have pre-punched mounting holes, proceed as follows:

RIMS WITH FOUR OR EIGHT HOLE STUD PATTERN:

Choose stud holes that are opposite each other as shown below. Using the center of opposite holes, scribe two lines on the rim web to divide the circumference into four equal parts. Measure in one inch from the outer edge of the web on each of the lines drawn. Mark this point as the center. Drill four 1/2" holes for mounting the magnets.

NOTE: Distance (D) between each set of drilled holes must be equal within 1/8" [3 mm] to ensure accuracy of system.

RIMS WITH SIX HOLE STUD PATTERN:

Locate the center of the holes to be drilled by using the rim webbing as a guide. Obtain a small piece of wood and cut to fit exactly over the web as shown. Measure the length of the piece of wood and mark the center on one edge. Using the center mark on the piece of wood, mark each of the four webs. Measure in one inch from the outer edge of the web on each of the lines drawn. Mark this point as center and drill four 1/2" holes for mounting the magnets.

NOTE: Distance (D) between each set of drilled holes must be equal within 1/8" [3 mm] to ensure accuracy of system.

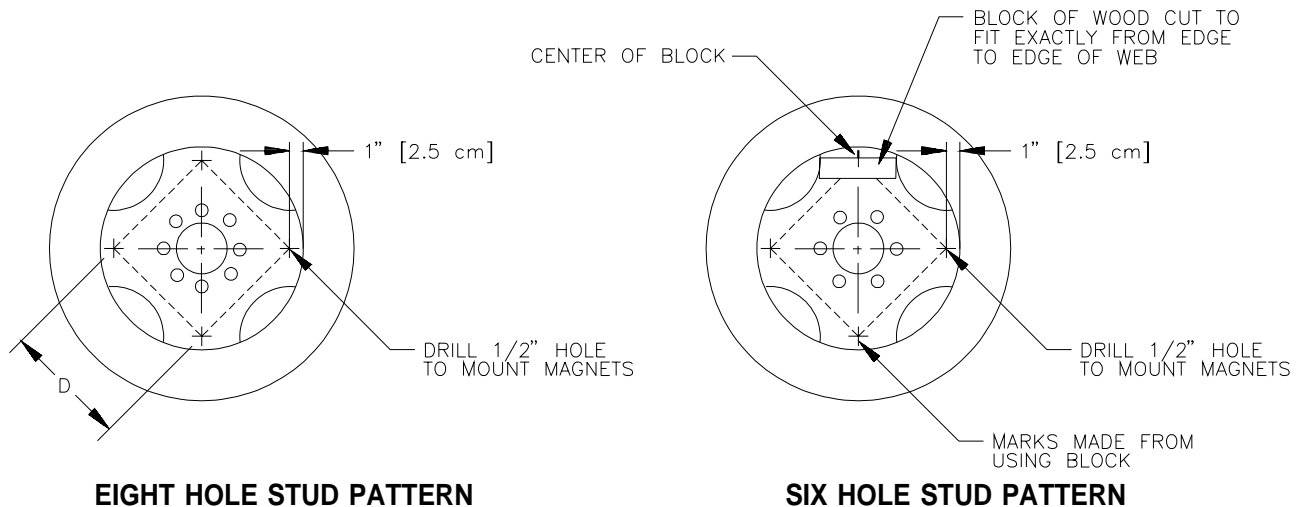

3. CALCULATING "SPEED CAL"

- 1) Place a chalk mark or tape onto the vehicle tire that the Speed Sensor mounted to it as shown below.
- 2) Mark the initial spot on the ground.
- 3) Drive vehicle straight ahead counting 10 full revolutions of the wheel. The mark must stop at the same position it was in when the vehicle started.
- 4) Measure the distance from the ground starting mark to stopping mark in inches [dm] (Round off fractions).
- 5) Write down this distance as the SPEED CAL number; keep it for future reference when programming the Console.

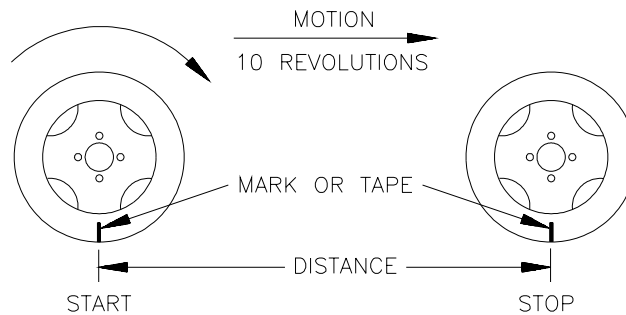

NOTE: This measurement is critical to the performance of the Console. **MEASURE CAREFULLY.** Be sure tire is properly inflated before measuring. Measure tire in type of soil in which you will be spraying. Circumference of tire will vary when measured in soft soil versus hard packed soil. For best results, measure several times and average the results.

Large tires and very low speed applications may require additional magnets to insure accurate speed readings. Any even number of magnets may be used as long as they are of alternating color and equally spaced. After calculating "SPEED CAL", this number must be adjusted according to the number of magnets used.

$$\frac{\text{Normal Number of Magnets}}{\text{Actual Number of Magnets}} \times \text{Speed Cal} = \text{Adjusted Speed Cal}$$

Example: $\frac{4}{6} \times 1200 = 800$

SCS 330, SCS 500 and SCS 550 normally use two magnets. All other consoles normally use four magnets.

APPENDIX 2

SPEEDOMETER DRIVE SPEED SENSOR INSTALLATION AND CALIBRATION PROCEDURE

1. MOUNTING THE SPEEDOMETER DRIVE SPEED SENSOR

- 1) Remove the existing speedometer cable from the back of the vehicle speedometer. Pull cable through fire wall into engine compartment.
- 2) Install adapter and key on speedometer cable and connect to Transducer Assembly. (Some units do not use adapter and key).
- 3) Connect Extension Cable to Transducer Assembly.

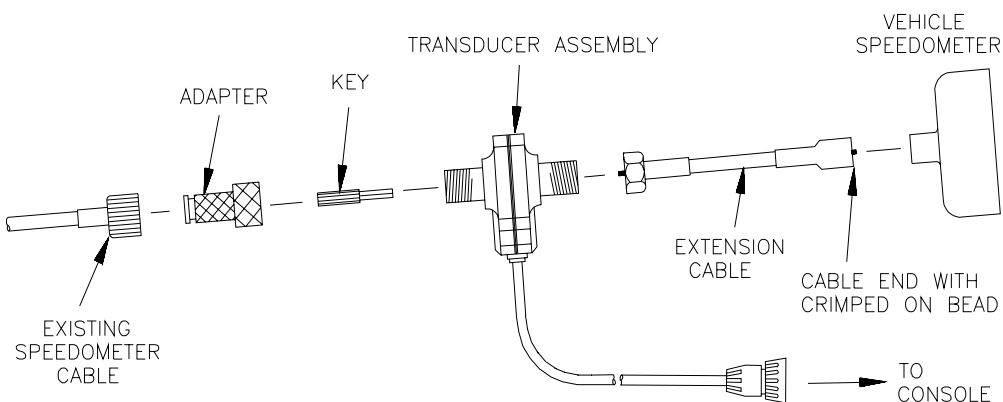

- 4) Push Extension Cable through fire wall and re-install on speedometer.
- 5) Connect the cable on the Transducer Assembly to the Console.
- 6) Secure all cables with plastic cable ties.

You are now ready to calibrate the Speedometer Drive Speed Sensor.

2. CALCULATING "SPEED CAL"

1) Complete "INITIAL CONSOLE PROGRAMMING" before doing this procedure.

2) Enter "0" in key labelled



3) Enter a SPEED CAL of 612 [155] in key labelled



4) Drive 1 mile [1 km].

CAUTION: Do not use vehicle odometer to determine distance. Use section lines or Highway markers.

5) Read DISTANCE by depressing key labelled



a) DISTANCE should read a value of approximately 5280 [1000]. If it reads between 5200-5350 [990-1010], the SPEED CAL for your vehicle is 612 [155].

b) If the DISTANCE display reads any other value, perform the following calculation:

Multiply the SPEED CAL by the target distance reading, then divide the sum by the actual value in DISTANCE display. This will give you the corrected value to enter for SPEED CAL. **You must round off to the nearest 3 digit whole number.**

EXAMPLE: SPEED CAL = 612 [155]
 Target distance reading = 5280 [1000]
 Assume the actual DISTANCE display reads 5000 [980]

$$\text{ENGLISH UNITS:}$$
$$= \frac{612 \times 5280}{5000} = 646.3$$

$$\text{METRIC UNITS:}$$
$$= \frac{[155] \times [1000]}{[980]} = [158.1]$$

6) The corrected number to enter for SPEED CAL is 646 [158].

7) Verify the corrected SPEED CAL number calculated above:

a) Zero out the DISTANCE display as in Step 2.

b) Enter the corrected SPEED CAL number as in Step 3.

c) Repeat Steps 4 and 5a. If DISTANCE value does not read correctly repeat Steps 5b, 6, and 7.

APPENDIX 3

ALTERNATE BY-PASS LINE PLUMBING SYSTEM

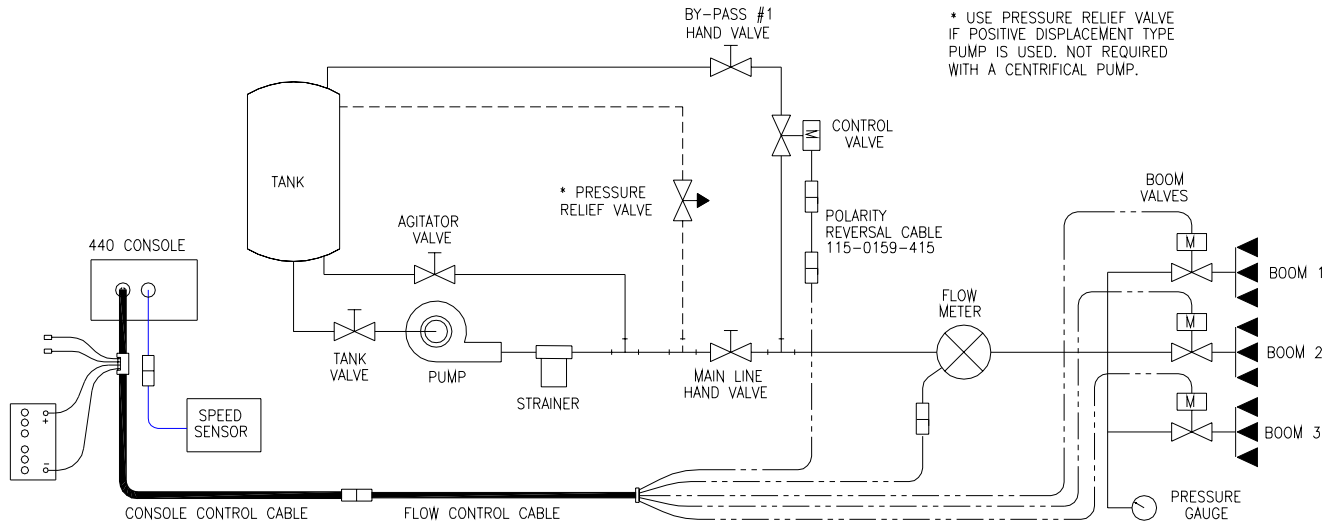

FIGURE 11

INITIAL SYSTEM SET-UP

Plumb the system as shown in Figure 11.

Adjust as follows:

Install Polarity Reversal Jumper in motorized Control Valve Cable (P/N 115-0159-415).

- 1) Fill tank with water only.
- 2) Place MASTER ON/OFF switch to ON and BOOM ON/OFF switches to OFF.
- 3) Place AUTO/MAN/OFF switch to MAN, and POWER ON/OFF switch to ON.
- 4) Verify that Boom Widths, SPEED CAL, METER CAL, and RATE CALS have been entered correctly into the Console. In SELF TEST mode enter the normal sprayer operating speed.
- 5) With pump not running, fully open main line hand valve, fully open by-pass #1 hand valve, and completely close agitator line hand valve. If positive displacement pump is used, fully open the pressure relief valve (PRV).
- 6) Run pump at normal operating RPM.
- 7) If centrifugal pump is used, proceed with Step 8. If positive displacement pump is used, proceed as follows:
 - a) Place MASTER ON/OFF switch to OFF.
 - b) Close by-pass #1 hand valve.
 - c) Set PRV to 65 psi [450 kPa].
 - d) Open by-pass #1 hand valve.
 - e) Place MASTER ON/OFF switch to ON.

- 8) Verify that each boom valve operates and that no nozzles are plugged by operating the BOOM ON/OFF switches.
- 9) Place all BOOM ON/OFF switches to ON.
- 10) Hold the FLOW CONTROL switch to INC position for approximately 12 seconds. This assures motorized Control Valve is fully closed. (Pressure gauge is not supplied).

NOTE: A pressure gauge MUST be installed to properly adjust the system.

- 11) Adjust agitator line hand valve for desired agitation.
- 12) Close the main line hand valve, if necessary, to set the desired maximum operating pressure. Maximum pressure should be approximately 10 psi [70 kPa] above normal spraying pressure.
EXAMPLE: If normal spraying pressure is 30 psi [210kPa], set maximum pressure at approximately 40 psi [280 kPa].
- 13) Hold the MAN ADJ switch to DEC position for approximately 12 seconds. This assures motorized Control Valve is fully open.
- 14) Close by-pass #1 hand valve to set the desired minimum operating pressure. Minimum pressure should be approximately one half the normal spraying pressure.
EXAMPLE: If normal spraying pressure is 30 psi [210 kPa], set minimum pressure at approximately 15 psi [105 kPa].
- 15) Verify maximum and minimum pressures and RATE by repeating Steps 11 and 14.

INITIAL SYSTEM FIELD TEST

- 1) Drive down field or road at target speed with sprayer booms OFF, to verify SPEED readout on Console.
- 2) Turn on sprayer and booms and place the MAN/AUTO switch to AUTO. Increase or decrease speed by one (1) MPH [2 km/h]. The system should automatically correct to the target application rate.
- 3) If for any reason, the system is unable to correct to the desired RATE, check for an empty tank, a plugged line, a malfunctioning pump, improper vehicle speed or a defect in the system.
- 4) If the system does not appear to be correcting properly, first review INITIAL SYSTEM SET-UP, then refer to TROUBLESHOOTING GUIDE.
- 5) At the end of each row, switch the MASTER ON/OFF to OFF to shut off flow. This also shuts off the area totalizer.
- 6) Verify area covered and volume used.

APPENDIX 4

PROCEDURE TO TEST SPEED SENSOR EXTENSION CABLES

Verify that the Console is in the SP1 Speed Sensor mode while testing the cable. Disconnect extension cable from Speed Sensor Assembly cable. Hold extension cable connector so that keyway is pointing in the 12 o'clock position.

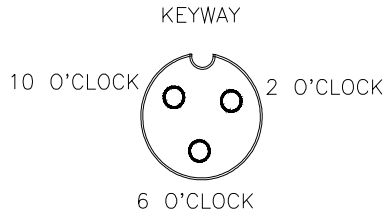

PIN DESIGNATIONS



- 2 o'clock socket location is power.
- 10 o'clock socket location is ground.
- 6 o'clock socket location is signal.

VOLTAGE READINGS

- 1) 10 o'clock socket to 6 o'clock socket = +5 VDC.
- 2) 10 o'clock socket to 2 o'clock socket = +5 VDC.

If a +5 VDC voltage reading is not present, disconnect the Flow Sensor cable. If the Speed reading is restored, Test the Flow Sensor cable per Appendix "PROCEDURE TO TEST FLOW METER CABLES".

PROCEDURE TO CHECK CABLE:

- 1) Enter SPEED CAL number of 1000 in key labelled .
- 2) Depress key labelled .
- 3) With small jumper wire (or paper clip), short between the 10 o'clock and 6 o'clock sockets with a "short-no short" motion. Each time a contact is made, the DISTANCE total should increase by increments of 1 or more counts.
- 4) If DISTANCE does not increase, remove the section of cable and repeat test at connector next closest to Console. Replace defective cable as required.
- 5) Perform above voltage checks.
- 6) If all cables test good, replace Speed Sensor.

NOTE: After testing is complete, re-enter correct SPEED CAL number before application.

APPENDIX 5

PROCEDURE TO TEST FLOW METER CABLES

Disconnect cable from Flow Sensor. Hold Flow Sensor cable so that the keyway is pointing in the 12 o'clock position:

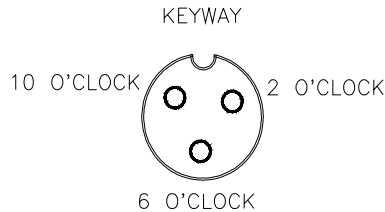

PIN DESIGNATIONS

- 2 o'clock socket location is ground.
- 10 o'clock socket location is power.
- 6 o'clock socket location is signal.

VOLTAGE READINGS

- 1) 2 o'clock socket to 6 o'clock socket = +5 VDC.
- 2) 2 o'clock socket to 10 o'clock socket = +5 VDC.

If a +5 VDC voltage reading is not present, disconnect the Speed Sensor cable. If the Flow reading is restored, Test the Speed Sensor cable per Appendix "PROCEDURE TO TEST SPEED SENSOR EXTENSION CABLES".

PROCEDURE TO CHECK CABLE:

- 1) Enter a METER CAL number of one (1) in key labelled .
- 2) Depress key labelled .
- 3) Place BOOM switches to ON.
- 4) With small jumper wire (or paper clip), short between the 2 o'clock and 6 o'clock sockets with a "short-no short" motion. Each time a contact is made, the TOTAL VOLUME should increase by increments of 1 or more counts.
- 5) If TOTAL VOLUME does not increase, remove the section of cable and repeat test at connector next closest to Console. Replace defective cable as required.
- 6) Perform above voltage checks.
- 7) If all cables test good, replace Flow Sensor.

NOTE: After testing is complete, re-enter correct METER CAL numbers before application.

APPENDIX 6

FLOW METER MAINTENANCE AND ADJUSTMENT PROCEDURE



- 1) Remove Flow Meter from sprayer and flush with clean water to remove any chemicals.

NH₃ WARNING: Thoroughly bleed nurse tank hose and all other system lines prior to disassembling the Flow Meter, fittings, and hoses.

- 2) Remove flange bolts or clamp from the Flow Meter.
- 3) Remove the turbine hub and turbine from inside Flow Meter.
- 4) Clean turbine and turbine hub of metal filings or any other foreign material, such as wettable powders. Confirm that the turbine blades are not worn. Hold turbine and turbine hub in your hand and spin turbine. The turbine should spin freely with very little drag inside the turbine hub.
- 5) If transducer assembly is replaced or if turbine stud is adjusted or replaced, verify the turbine fit before reassembling. Hold turbine hub with turbine on transducer. Spin turbine by blowing on it. Tighten turbine stud until turbine stalls. Loosen turbine stud 1/3 turn. The turbine should spin freely.
- 6) Re-assemble Flow Meter.
- 7) Using a low pressure (5 psi) [34.5 kPa] jet of air, verify the turbine spins freely. If there is drag, loosen hex stud on the bottom of turbine hub 1/16 turn until the turbine spins freely.
- 8) If the turbine spins freely and cables have been checked per Appendix "PROCEDURE TO TEST FLOW CABLES", but Flow Meter still is not totalizing properly, replace Flow Meter transducer.

APPENDIX 7

PROCEDURE TO RE-CALIBRATE FLOW METER

- 1) Enter a METER CAL number of 10 [38] in the key labelled 
- 2) Enter a TOTAL VOLUME of 0 in the key labelled 
- 3) Switch OFF all booms.
- 4) Remove a boom hose and place it into a calibrated 5 gallon [19 liter] container.
- 5) Switch ON appropriate boom switch (for the hose that was just placed into the 5 gallon container) and the MASTER switch. Pump exactly 10 gallons [38 liters].
- 6) Readout in TOTAL VOLUME is the new METER CAL number. This number should be within +/- 3% of the calibration number stamped on the tag of the Flow Meter.
- 7) Repeat this procedure several times to confirm accuracy. (Always "zero out" the TOTAL VOLUME display before retesting).

NOTE: For greatest precision, set METER CAL to 100 and pump 100 gallons (378 liters) of water.

- 8) To verify Flow Meter calibration, fill applicator tank with a predetermined amount of measured liquid (i.e. 250 gallons). **DO NOT RELY ON GRADUATION NUMBERS MOLDED INTO APPLICATOR TANK.** Empty the applicator tank under normal operating conditions. If the number displayed under TOTAL VOLUME is different from the predetermined amount of measured liquid by more than +/- 3%, complete the following calculation:

EXAMPLE:

METER CAL	=	720 [190]
TOTAL VOLUME	=	260 [984]
Predetermined amount of measured liquid	=	250 [946]

Corrected METER CAL = $\frac{\text{METER CAL} \times \text{TOTAL VOLUME}}{\text{Predetermined amount of measured liquid}}$

ENGLISH UNITS:	METRIC UNITS:
= $\frac{720 \times 260}{250} = 749$	= $\frac{[190] \times [984]}{[946]} = [198]$

Corrected METER CAL = 749 [198]

- 9) Enter corrected METER CAL before resuming application.

APPENDIX 8

REMOTE SWITCH OPTION

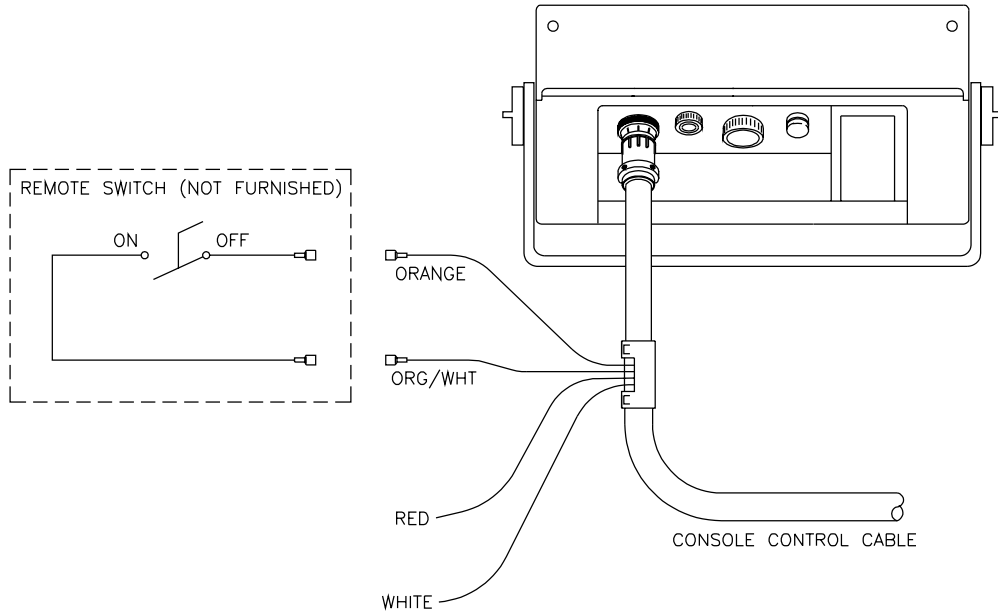
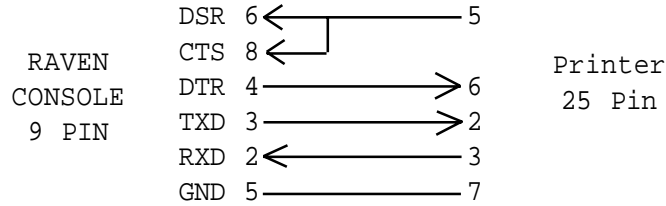

FIGURE 12

The REMOTE switch when installed is in parallel with the MASTER switch; therefore switching on the REMOTE switch OR the MASTER switch will energize the boom valves.

APPENDIX 9 SERIAL INTERFACE

1) Cable pinout (P/N 115-0159-994), supplied with Thermal Printer Kit (P/N 117-0159-529).



2) Changing RATE 1 CAL by remote computer.
a) Configuration of RS-232C serial port:

1200 or 9600 Baud Rate
NO Parity
8 Data Bits
2 Stop Bits

b) Data stream to Raven Console.

EXAMPLE: Change RATE 1 to 123.4

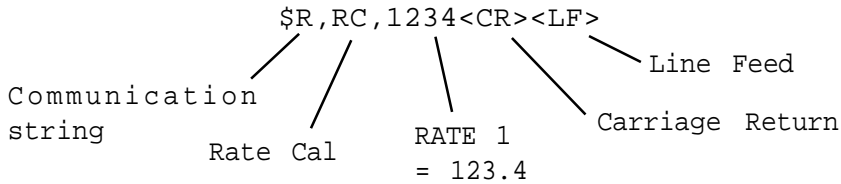

Decimal point is not sent from Remote Computer to Raven Console.

3) Optional 9 pin to 9 pin cable pinout (P/N 115-0159-822).

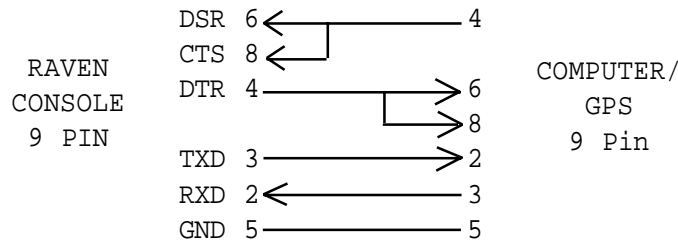

APPENDIX 10

SCS 440 COMMUNICATION STRINGS

REMOTE COMPUTER TO SCS 440 CONSOLE

All request strings begin with \$R, to indicate a Raven communication string.

Rate 1 Change Request:

\$R,RC,<rate_1_cal><CR><LF>

Calibration String Values Request:

\$R,CR<CR><LF>

Data String Request:

\$R,DR<CR><LF>

SCS 440 CONSOLE TO REMOTE COMPUTER

All console output strings begin with \$R035J, the \$R indicates a Raven communication string, the 035 is the last three digits of the current SCS 440 programmed chip part number and J is the software revision number.

Calibration Strings:

\$R035J,C1,<switch_byte_1>,<switch_byte_2>,<boom_1_cal>,
<boom_2_cal>,<boom_3_cal>,<speed_cal> <CR><LF>

\$R035J,C2,<meter_cal>,<CR><LF>

\$R035J,C3,<valve_cal>,<rate_1_cal>,<rate_2_cal><CR><LF>

Bit	Switch Byte 1	Switch Byte 2
0	boom 1	0
1	boom 2	0
2	boom 3	0
3	0	rate 1
4	0	rate 2
5	0	0
6	0	0
7	1	1

NOTE: If rate 1 and rate 2 are both zero, the console is in Manual. For switch Byte Bits; 0 = off and 1 = on.

Data Strings:

\$R035J,D1,<total_area>,<field_area><CR><LF>

\$R035J,D2,<total_volume>,<field_volume><CR><LF>

\$R035J,D3,<tank_volume>,<distance><CR><LF>

Actual Rate:

\$R035J,AR,<actual_rate><CR><LF>

Time/Date:

\$R035J,TD,<hr:min>,<month/day/year>,<field_reference><CR><LF>